

Chilux FS



Chilux FS



Comfort

Basic soft (K1)

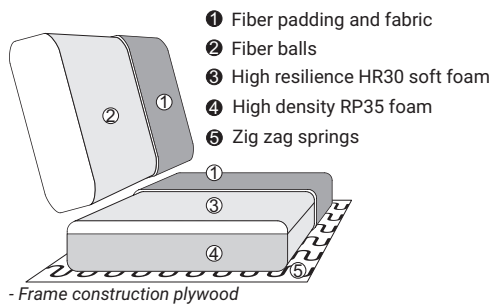

Extra dimensions

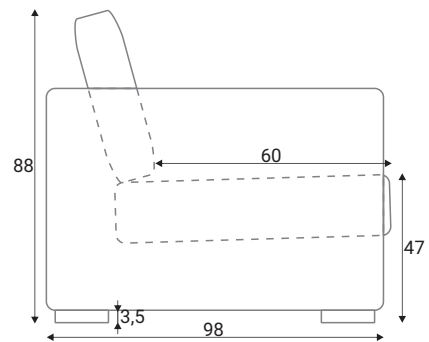

Legs



W17,
Solid wood, painted black



W28,
Solid wood, painted black

Accessories

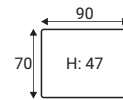

Footstool F05

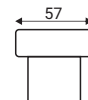

Neckrest

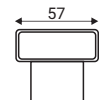

Neckrest FS

Armrests

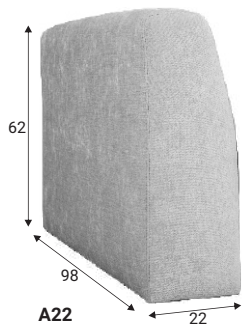

A22

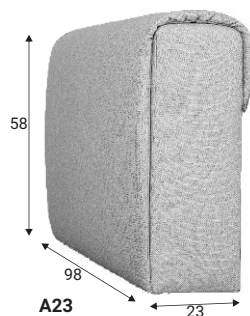

A23

Back cushion options



Standard back cushion



FS* back cushion
*FS back cushions with 30mm FR seam

Decorative pillows

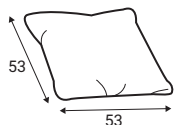

Pillow D1

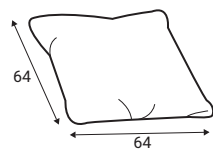

Pillow D2

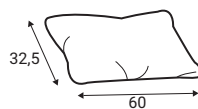

Pillow D3

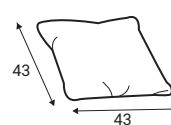

Pillow D5

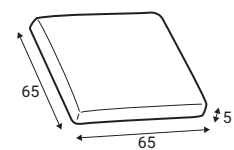

Pillow D18

reserves the right to change construction of products and components used due to improving durability of product and customer satisfaction without any further notice. Upholstered furniture is handmade using soft materials there fore measurements may vary up to +/- 3cm. Slight colour variations may occur between production batches. For technological reasons variations in color shades are acceptable.

Chilux FS



Deco EV pillows

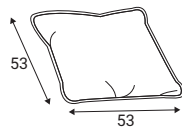

Pillow D1 FS

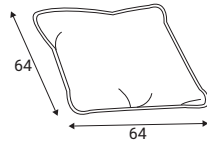

Pillow D2 FS

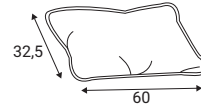

Pillow D3 FS

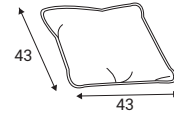

Pillow D5 FS

FS back cushions with 30mm FR seam

Standard sets

Dimensions with A23 armrest and W17 legs

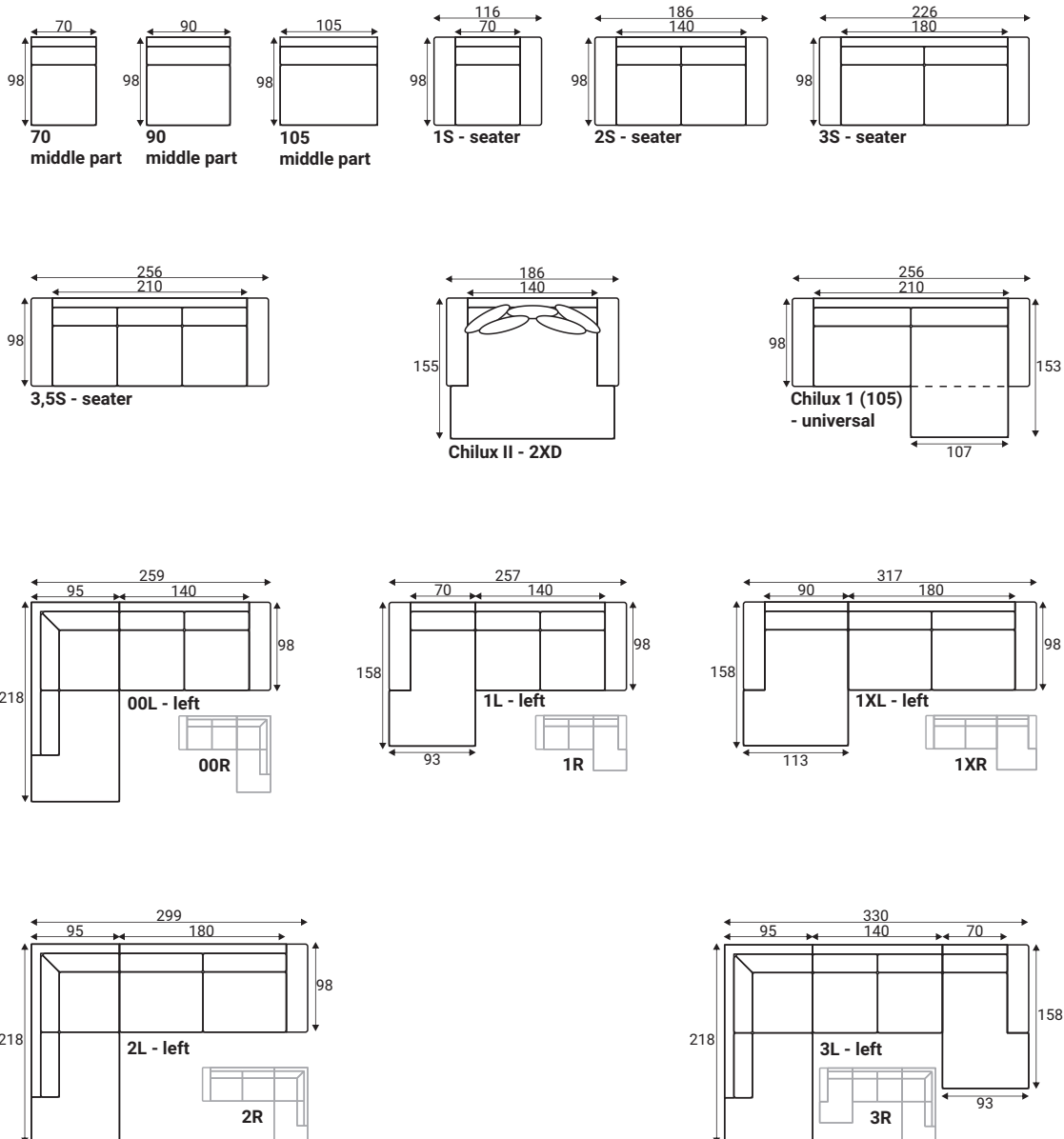

reserves the right to change construction of products and components used due to improving durability of product and customer satisfaction without any further notice. Upholstered furniture is handmade using soft materials there fore measurements may vary up to +/- 3cm. Slight colour variations may occur between production batches. For technological reasons variations in color shades are acceptable.



Chilux FS

Standard sets

Dimensions with A23 armrest and W17 legs

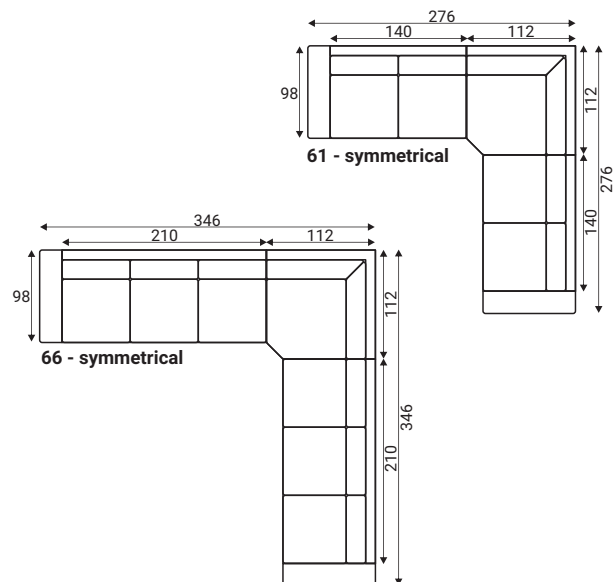
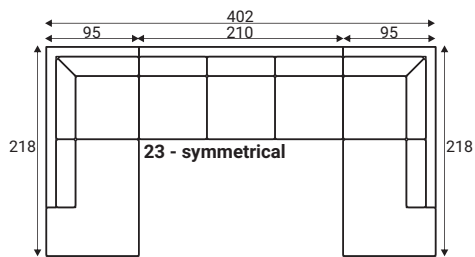
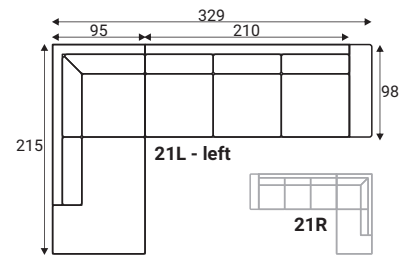
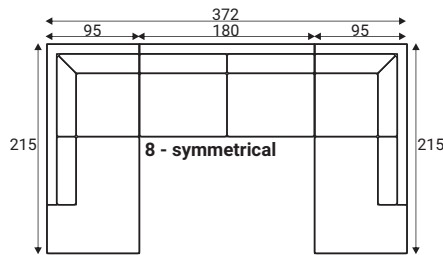
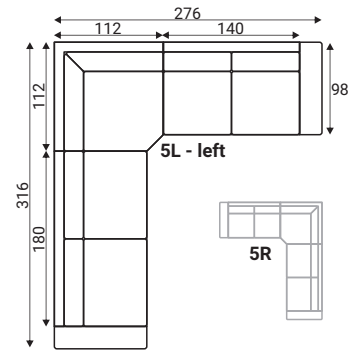
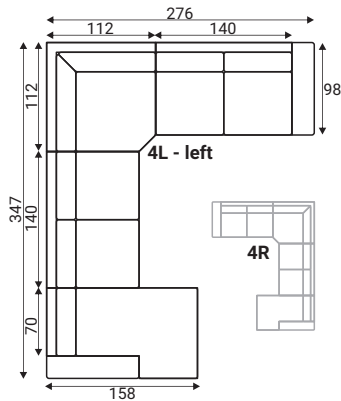

Furniture features in symbols



- Seat and back cushions are loose from the frame.



- Fabric



- Removable cover for loose cushions.
(For maintenance please check fabric information.)

reserves the right to change construction of products and components used due to improving durability of product and customer satisfaction without any further notice. Upholstered furniture is handmade using soft materials there fore measurements may vary up to +/- 3cm. Slight colour variations may occur between production batches. For technological reasons variations in color shades are acceptable.